



Figure can vary

Part no.: 50134294
PRK25C.D/2N-200-M12
Polarized retro-reflective photoelectric sensor



Contents

- Technical data
- Reflectors & reflective tapes
- Dimensioned drawings
- Electrical connection
- Diagrams
- Operation and display
- Part number code
- Accessories
- Notes

Technical data

| Basic data | |
|-------------------------------------|---|
| Series | 25C |
| Operating principle | Reflection principle |
| Application | Detection of stretch-wrapped objects |
| Optical data | |
| Operating range | Guaranteed operating range |
| Operating range | 0 ... 8 m, With reflector TK(S) 100x100 |
| Operating range limit | Typical operating range |
| Operating range limit | 0 ... 10 m, With reflector TK(S) 100x100 |
| Light source | LED, Red |
| LED light wavelength | 640 nm |
| Transmitted-signal shape | Pulsed |
| LED protection class | Exempt group (in acc. with EN 62471) |
| Electrical data | |
| Protective circuit | Polarity reversal protection Short circuit protected |
| Performance data | |
| Supply voltage | 10 ... 30 V, DC, Incl. residual ripple |
| Residual ripple | 0 ... 15 %, From U_B |
| Open-circuit current | 0 ... 20 mA |
| Outputs | |
| Number of digital switching outputs | 2 Piece(s) |
| Switching outputs | |
| Voltage type | DC |
| Switching current, max. | 100 mA |
| Switching voltage | low: $\leq 2.5V$ high: $\geq (U_B - 2.5V)$ |
| Switching output 1 | |
| Assignment | Connection 1, pin 4 |
| Switching element | Transistor, NPN |
| Switching principle | Light switching |
| Switching output 2 | |
| Assignment | Connection 1, pin 2 |
| Switching element | Transistor, NPN |
| Switching principle | Dark switching |
| Timing | |
| Switching frequency | 1,500 Hz |
| Response time | 0.33 ms |
| Readiness delay | 300 ms |
| Connection | |

Connection 1

| | |
|--------------------|------------------------------|
| Type of connection | Cable with connector |
| Function | Signal OUT Voltage supply |
| Cable length | 200 mm |
| Sheathing material | PUR |
| Cable color | Black |
| Wire cross section | 0.2 mm ² |
| Thread size | M12 |
| Type | Male |
| Material | PUR |
| No. of pins | 4 -pin |
| Encoding | A-coded |

Mechanical data

| | |
|----------------------------|--|
| Dimension (W x H x L) | 15 mm x 42.7 mm x 30 mm |
| Housing material | Metal Plastic, Diecast zinc, ABS |
| Lens cover material | Plastic |
| Net weight | 33 g |
| Housing color | Red |
| Type of fastening | Through-hole mounting with M4 thread Via optional mounting device |
| Compatibility of materials | ECOLAB |

Operation and display

| | |
|-----------------|------------|
| Type of display | LED |
| Number of LEDs | 2 Piece(s) |

Environmental data

| | |
|--------------------------------|---------------|
| Ambient temperature, operation | -40 ... 60 °C |
| Ambient temperature, storage | -40 ... 70 °C |

Certifications

| | |
|----------------------|-----------------|
| Degree of protection | IP 69K IP 67 |
| Protection class | III |
| Certifications | c UL US |
| Standards applied | IEC 60947-5-2 |

Classification

| | |
|------------|----------|
| eCl@ss 8.0 | 27270902 |
| eCl@ss 9.0 | 27270902 |
| ETIM 5.0 | EC002717 |

Reflectors & reflective tapes

| | Part no. | Designation | Operating range/ Operating range limit | Description |
|---|----------|-----------------|---|--|
|  | 50117583 | MTKS 50x50.1 | 0.05 ... 5 m 0.05 ... 6 m | Design: Rectangular Reflective surface: 50 mm x 50 mm Triple reflector size: 1.2 mm Material: Plastic Base material: Plastic Chemical designation of the material: PMMA8N Fastening: Through-hole mounting, Adhesive |
|  | 50106119 | REF 4-A-100x100 | 0.05 ... 2 m 0.05 ... 2.5 m | Design: Rectangular Reflective surface: 100 mm x 100 mm Material: Plastic Chemical designation of the material: PMMA Fastening: Self-adhesive |
|  | 50110192 | REF 6-A-50x50 | 0.05 ... 3.5 m 0.05 ... 4 m | Design: Rectangular Reflective surface: 50 mm x 50 mm Triple reflector size: 0.3 mm Material: Plastic Chemical designation of the material: PMMA Fastening: Self-adhesive |
|  | 50003192 | TK 100x100 | 0.05 ... 8 m 0.05 ... 10 m | Design: Rectangular Reflective surface: 96 mm x 96 mm Triple reflector size: 4 mm Material: Plastic Base material: Plastic Chemical designation of the material: PMMA8N Fastening: Adhesive |
|  | 50022816 | TKS 100X100 | 0.05 ... 8 m 0.05 ... 10 m | Design: Rectangular Reflective surface: 96 mm x 96 mm Triple reflector size: 4 mm Material: Plastic Base material: Plastic Chemical designation of the material: PMMA8N Fastening: Through-hole mounting, Adhesive |
|  | 50081283 | TKS 20X40 | 0.05 ... 2.5 m 0.05 ... 3 m | Design: Rectangular Reflective surface: 16 mm x 38 mm Triple reflector size: 2.3 mm Material: Plastic Base material: Plastic Chemical designation of the material: PMMA8N Fastening: Through-hole mounting, Adhesive |
|  | 50040820 | TKS 40X60 | 0.05 ... 4 m 0.05 ... 5 m | Design: Rectangular Reflective surface: 37 mm x 56 mm Triple reflector size: 4 mm Material: Plastic Base material: Plastic Chemical designation of the material: PMMA8N Fastening: Through-hole mounting, Adhesive |

Dimensioned drawings

All dimensions in millimeters

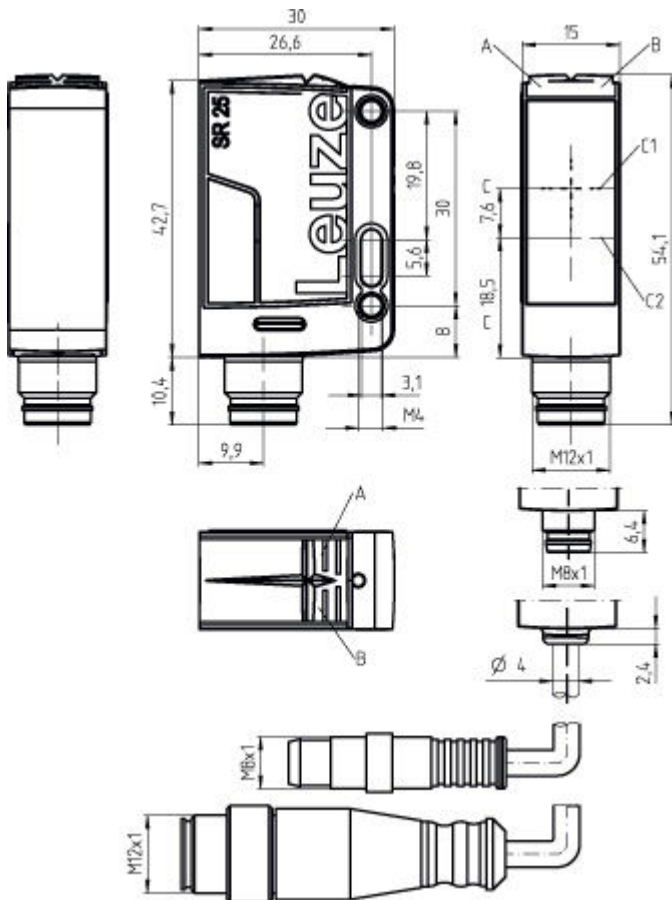

- A Green LED
- B Yellow LED
- C Optical axis
- C1 Receiver
- C2 Transmitter

Electrical connection

| Connection 1 | |
|--------------------|------------------------------|
| Type of connection | Cable with connector |
| Function | Signal OUT Voltage supply |
| Cable length | 200 mm |
| Sheathing material | PUR |
| Cable color | Black |
| Wire cross section | 0.2 mm ² |
| Thread size | M12 |
| Type | Male |
| Material | PUR |
| No. of pins | 4 -pin |
| Encoding | A-coded |

| Pin | Pin assignment |
|-----|----------------|
| 1 | V+ |
| 2 | OUT 2 |
| 3 | GND |
| 4 | OUT 1 |

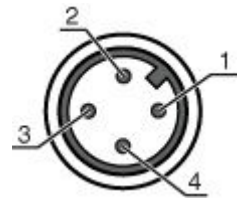

Diagrams

Typ. response behavior (TKS100x100)

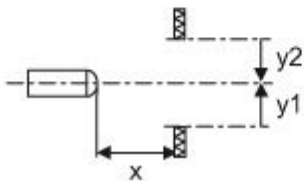
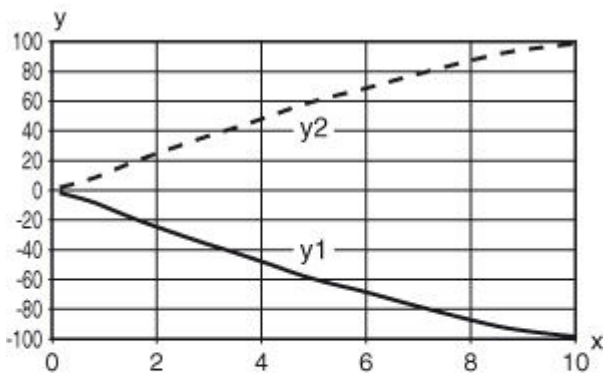

x Distance [m]
y Misalignment [mm]

Typ. function reserve

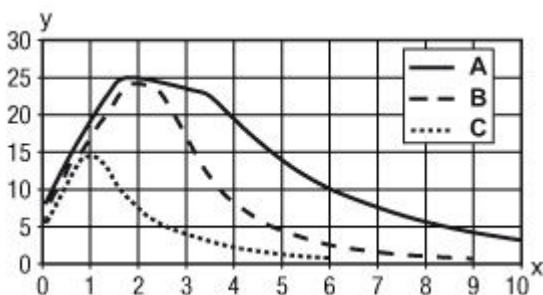

x Distance [m]
y Function reserve
A TKS 100x100
B TKS 40x60
C TKS 20x40

Part no.: 50134294 – PRK25C.D/2N-200-M12 – Polarized retro-reflective

Operation and display

LEDs

| LED | Display | Meaning |
|-----|--------------------------|--------------------------------------|
| 1 | Green, continuous light | Operational readiness |
| 2 | Yellow, continuous light | Light path free |
| | Yellow, flashing | Light path free, no function reserve |

Part number code

Part designation: **AAA25Cd-f.GGH/IJ-K**

| | |
|--------|--|
| AAA25C | Operating principle / construction: HT25C: diffuse reflection sensor with background suppression PRK25C: retro-reflective photoelectric sensor with polarization filter |
| d | Light type: n/a: red light l: infrared light |
| f | Pre-set range (optional): n/a: operating range acc. to data sheet XXXX: pre-set range [mm] |
| GG | Equipment: A: autocollimation principle (single lens) S: small light spot D: detection of stretch-wrapped objects X: extended model |
| H | Operating range adjustment: 1: 270° potentiometer 2: multiturn potentiometer |
| i | Switching output/function OUT 1/IN: Pin 4 or black conductor: 2: NPN transistor output, light switching N: NPN transistor output, dark switching 4: PNP transistor output, light switching P: PNP transistor output, dark switching |
| J | Switching output / function OUT 2/IN: pin 2 or white conductor: 2: NPN transistor output, light switching N: NPN transistor output, dark switching 4: PNP transistor output, light switching P: PNP transistor output, dark switching W: warning output 8: activation input (activation with high signal) |
| K | Electrical connection: n/a: cable, PVC, standard length 2000 mm, 4-wire M8: M8 connector, 4-pin (plug) 200-M12: cable, PVC, length 200 mm with M12 connector, 4-pin, axial (plug) M12: M12 connector, 4-pin (plug) |

Accessories

Connection technology - Connection cables

| | Part no. | Designation | Article | Description |
|---|----------|--------------------|------------------|---|
|  | 50130654 | KD U-M12-4A-P1-020 | Connection cable | Connection 1: Connector, M12, Axial, Female, A-coded, 4 -pin Connection 2: Open end Shielded: No Cable length: 2,000 mm Sheathing material: PUR |

Part no.: 50134294 – PRK25C.D/2N-200-M12 – Polarized retro-reflective

| | Part no. | Designation | Article | Description |
|---|----------|--------------------|------------------|---|
|  | 50130657 | KD U-M12-4A-P1-050 | Connection cable | Connection 1: Connector, M12, Axial, Female, A-coded, 4 -pin Connection 2: Open end Shielded: No Cable length: 5,000 mm Sheathing material: PUR |
|  | 50130658 | KD U-M12-4A-P1-100 | Connection cable | Connection 1: Connector, M12, Axial, Female, A-coded, 4 -pin Connection 2: Open end Shielded: No Cable length: 10,000 mm Sheathing material: PUR |
|  | 50130648 | KD U-M12-4A-V1-020 | Connection cable | Connection 1: Connector, M12, Axial, Female, A-coded, 4 -pin Connection 2: Open end Shielded: No Cable length: 2,000 mm Sheathing material: PVC |
|  | 50130652 | KD U-M12-4A-V1-050 | Connection cable | Connection 1: Connector, M12, Axial, Female, A-coded, 4 -pin Connection 2: Open end Shielded: No Cable length: 5,000 mm Sheathing material: PVC |
|  | 50130653 | KD U-M12-4A-V1-100 | Connection cable | Connection 1: Connector, M12, Axial, Female, A-coded, 4 -pin Connection 2: Open end Shielded: No Cable length: 10,000 mm Sheathing material: PVC |
|  | 50130692 | KD U-M12-4W-P1-020 | Connection cable | Connection 1: Connector, M12, Angled, Female, A-coded, 4 -pin Connection 2: Open end Shielded: No Cable length: 2,000 mm Sheathing material: PUR |
|  | 50130694 | KD U-M12-4W-P1-050 | Connection cable | Connection 1: Connector, M12, Angled, Female, A-coded, 4 -pin Connection 2: Open end Shielded: No Cable length: 5,000 mm Sheathing material: PUR |
|  | 50130695 | KD U-M12-4W-P1-100 | Connection cable | Connection 1: Connector, M12, Angled, Female, A-coded, 4 -pin Connection 2: Open end Shielded: No Cable length: 10,000 mm Sheathing material: PUR |
|  | 50130688 | KD U-M12-4W-V1-020 | Connection cable | Connection 1: Connector, M12, Angled, Female, A-coded, 4 -pin Connection 2: Open end Shielded: No Cable length: 2,000 mm Sheathing material: PVC |
|  | 50130690 | KD U-M12-4W-V1-050 | Connection cable | Connection 1: Connector, M12, Angled, Female, A-coded, 4 -pin Connection 2: Open end Shielded: No Cable length: 5,000 mm Sheathing material: PVC |



Part no.: 50134294 – PRK25C.D/2N-200-M12 – Polarized retro-reflective

| | Part no. | Designation | Article | Description |
|---|----------|--------------------|------------------|---|
|  | 50130691 | KD U-M12-4W-V1-100 | Connection cable | Connection 1: Connector, M12, Angled, Female, A-coded, 4 -pin Connection 2: Open end Shielded: No Cable length: 10,000 mm Sheathing material: PVC |

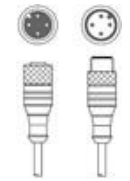

Connection technology - Interconnection cables

| | Part no. | Designation | Article | Description |
|---|----------|----------------------------|-----------------------|---|
|  | 50130738 | KDS U-M12-4A-M12-4A-P1-006 | Interconnection cable | Connection 1: Connector, M12, Axial, Female, A-coded, 4 -pin Connection 2: Connector, M12, Axial, Male, A-coded, 4 -pin Shielded: No Cable length: 600 mm Sheathing material: PUR |





Mounting technology - Mounting brackets

| | Part no. | Designation | Article | Description |
|---|----------|---------------|---------------------|---|
|  | 50124651 | BT 205M-10SET | Mounting device set | Contains: 10x Design of mounting device: Angle, L-shape Fastening, at system: Through-hole mounting Mounting bracket, at device: Screw type Type of mounting device: Rigid Material: Metal |
|  | 50040269 | BT 25 | Mounting device | Design of mounting device: Angle, L-shape Fastening, at system: Through-hole mounting Mounting bracket, at device: Screw type Type of mounting device: Rigid Material: Metal |





Mounting technology - Rod mounts

| | Part no. | Designation | Article | Description |
|---|----------|--------------|-----------------|--|
|  | 50117830 | BTP 200M-D10 | Mounting system | Design of mounting device: Protection hood Fastening, at system: For 10 mm rod Mounting bracket, at device: Screw type Type of mounting device: Clampable, Adjustable, Turning, 360° Material: Metal |
|  | 50117829 | BTP 200M-D12 | Mounting system | Design of mounting device: Protection hood Fastening, at system: For 12 mm rod Mounting bracket, at device: Screw type Type of mounting device: Clampable, Adjustable, Turning, 360° Material: Metal |
|  | 50117828 | BTP 200M-D14 | Mounting system | Design of mounting device: Protection hood Fastening, at system: For 14 mm rod Mounting bracket, at device: Screw type Type of mounting device: Clampable, Adjustable, Turning, 360° Material: Metal |

Part no.: 50134294 – PRK25C.D/2N-200-M12 – Polarized retro-reflective

| | Part no. | Designation | Article | Description |
|---|----------|--------------|-----------------|---|
|  | 50117256 | BTU 200M-D10 | Mounting system | Contains: 2x M3 x 18 screw, 2x position washers Design of mounting device: Mounting system Fastening, at system: For 10 mm rod, Sheet-metal mounting Mounting bracket, at device: Screw type Type of mounting device: Clampable, Adjustable, Turning, 360° Material: Metal |
|  | 50117255 | BTU 200M-D12 | Mounting system | Contains: 2x M3 x 18 screw, 2x position washers Design of mounting device: Mounting system Fastening, at system: For 12 mm rod, Sheet-metal mounting Mounting bracket, at device: Screw type Type of mounting device: Clampable, Adjustable, Turning, 360° Material: Metal |
|  | 50117254 | BTU 200M-D14 | Mounting system | Contains: 2x M3 x 18 screw, 2x position washers Design of mounting device: Mounting system Fastening, at system: For 14 mm rod, Sheet-metal mounting Mounting bracket, at device: Screw type Type of mounting device: Clampable, Adjustable, Turning, 360° Material: Metal |
|  | 50122797 | BTU 346M-D12 | Mounting system | Contains: 2x M4 x 25 screw, 2x position washers Design of mounting device: Mounting system Fastening, at system: For 12 mm rod, Sheet-metal mounting Mounting bracket, at device: Screw type Type of mounting device: Turning, 360°, Clampable, Adjustable Material: Metal |

Standard reflectors



| | Part no. | Designation | Article | Description |
|---|----------|-------------|-----------|--|
|  | 50003192 | TK 100x100 | Reflector | Design: Rectangular Reflective surface: 96 mm x 96 mm Triple reflector size: 4 mm Material: Plastic Base material: Plastic Chemical designation of the material: PMMA8N Fastening: Adhesive |
|  | 50022816 | TKS 100X100 | Reflector | Design: Rectangular Reflective surface: 96 mm x 96 mm Triple reflector size: 4 mm Material: Plastic Base material: Plastic Chemical designation of the material: PMMA8N Fastening: Through-hole mounting, Adhesive |
|  | 50081283 | TKS 20X40 | Reflector | Design: Rectangular Reflective surface: 16 mm x 38 mm Triple reflector size: 2.3 mm Material: Plastic Base material: Plastic Chemical designation of the material: PMMA8N Fastening: Through-hole mounting, Adhesive |
|  | 50040820 | TKS 40X60 | Reflector | Design: Rectangular Reflective surface: 37 mm x 56 mm Triple reflector size: 4 mm Material: Plastic Base material: Plastic Chemical designation of the material: PMMA8N Fastening: Through-hole mounting, Adhesive |

Part no.: 50134294 – PRK25C.D/2N-200-M12 – Polarized retro-reflective

Micro-triad-type reflectors

| | Part no. | Designation | Article | Description |
|---|----------|--------------|-----------|--|
|  | 50117583 | MTKS 50x50.1 | Reflector | Design: Rectangular Reflective surface: 50 mm x 50 mm Triple reflector size: 1.2 mm Material: Plastic Base material: Plastic Chemical designation of the material: PMMA8N Fastening: Through-hole mounting, Adhesive |

Reflective tapes for standard applications

| | Part no. | Designation | Article | Description |
|--|-----------|-----------------|-----------------|--|
|  | 501106119 | REF 4-A-100x100 | Reflective tape | Design: Rectangular Reflective surface: 100 mm x 100 mm Material: Plastic Chemical designation of the material: PMMA Fastening: Self-adhesive |
|  | 50110192 | REF 6-A-50x50 | Reflective tape | Design: Rectangular Reflective surface: 50 mm x 50 mm Triple reflector size: 0.3 mm Material: Plastic Chemical designation of the material: PMMA Fastening: Self-adhesive |

Notes

Observe intended use!

- This product is not a safety sensor and is not intended as personnel protection.
- The product may only be put into operation by competent persons.
- Only use the product in accordance with its intended use.

For UL applications:

- Only for use in "class 2" circuits
- These proximity switches shall be used with UL Listed Cable assemblies rated 30V, 0.5A min, in the field installation, or equivalent (categories: CYJV/CYJV7 or PVVA/PVVA7)

- Light source: Average life expectancy 100,000 h at an ambient temperature of 25 °C
- Sum of the output currents for both outputs 100 mA